









Solution product list

Product Name	Description
 SEMAC-S1	Single door Access control panel (1 door Bidirectional or 2 doors Single directional)
SEMAC-S2	Multi door Access control panel (8 door-16 external readers supported, BF-50 needed)
SEMAC-S3	Multi door Access control panel (Floor Control special version, BF-333 & BF-20 needed)
 WEBPASS-Lite	IP65 Rating Weather proof WIEGAND reader
 BF-603A/B/C/D	WIEGAND card readers
 BF-20 (Solution 3 required)	Relay box
 BF-50 (Solution 2 required)	Relay box with two WIEGAND ports and on board LED indicators
 BF-333	Floor Controller (Solution 3 required)
 Case-SEM MAC-00 (Option)	Power Box for SEMAC series
 POW-00-SEM MAC-1203 (Option)	12V/3A Power Supply for SEMAC power box
 EM-302(EM)/MF-302(EM)/ MR-601 (Mifare)	RFID Card decoder/ encoder (MR-601)

CHIYU TECHNOLOGY CO., LTD

Chiayi, Taiwan
 TEL: 886-5-2325465
 FAX: 886-5-2910918
 No. 293, Siwei Road, Chiayi City 60085, Taiwan
<http://www.chiyu-t.com.tw> mail: sales@chiyu-t.com.tw

Taipei, Taiwan
 TEL: 886-2-25491289
 FAX: 886-2-25491299
 10F-1, No.32, Sec. 1, Chengde Rd., Datong District, Taipei
 City 10349, Taiwan

Kaohsiung, Taiwan
 TEL: 886-7-5377575
 FAX: 886-7-5372020
 8F-15, No.12, Fuxing 4th Rd. Cianjhen Dist., Kaohsiung
 City 80661, Taiwan (Kaohsiung Software Technology Park)

Shenzhen, China
 TEL : 86-755-82514171
 FAX : 86-755-82514169
 Room 909, Section B, Zhong Shen Garden, Cai
 Tian South Road, Fu Tian District, Shen Zhen, China

Access Control Panel

SEM MAC

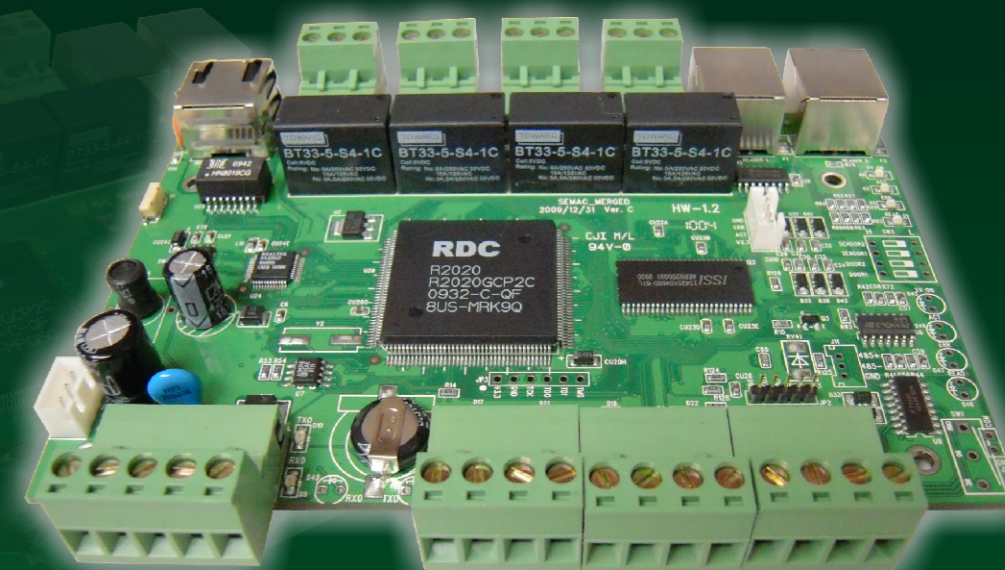

Smart Ethernet Multi-door Access Controller

- Single door & Multi door flexible solution provided
- Web based management
- Multiple on-board I/O and relay for higher security
- Hardware reset button featured
- Compact size panel design for easily system installation
- Higher access security mechanism featured thru Web configuration
- Master/Slave architecture supported (SEM MAC-S3 only)
- Proprietary management software provided

Application

1. SEMAC-S1:

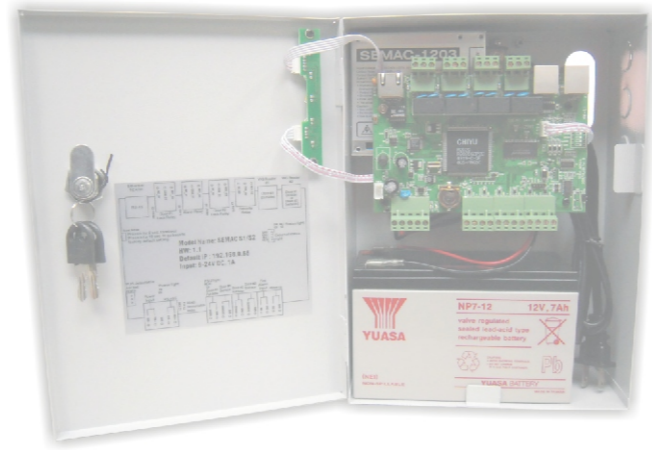
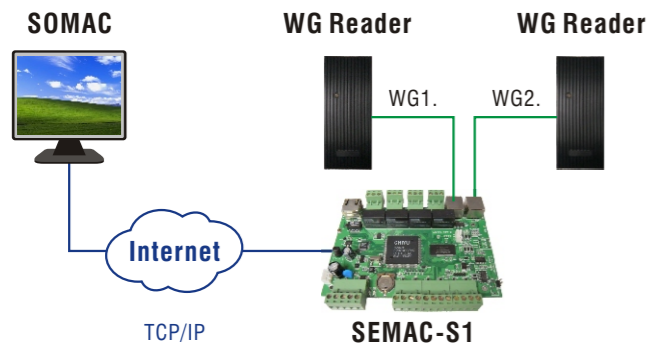

3. SEMAC-S3:

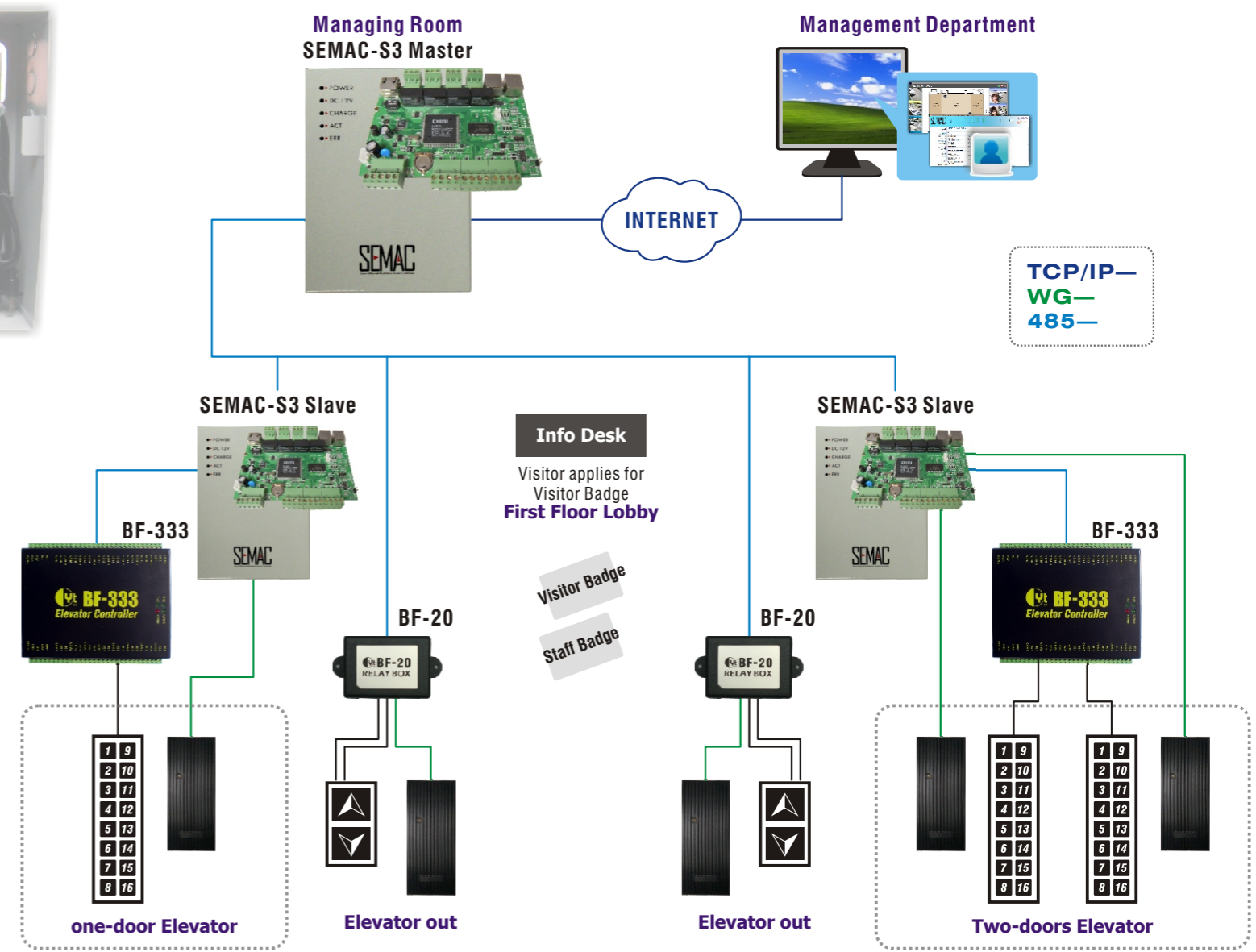

2. SEMAC-S2:

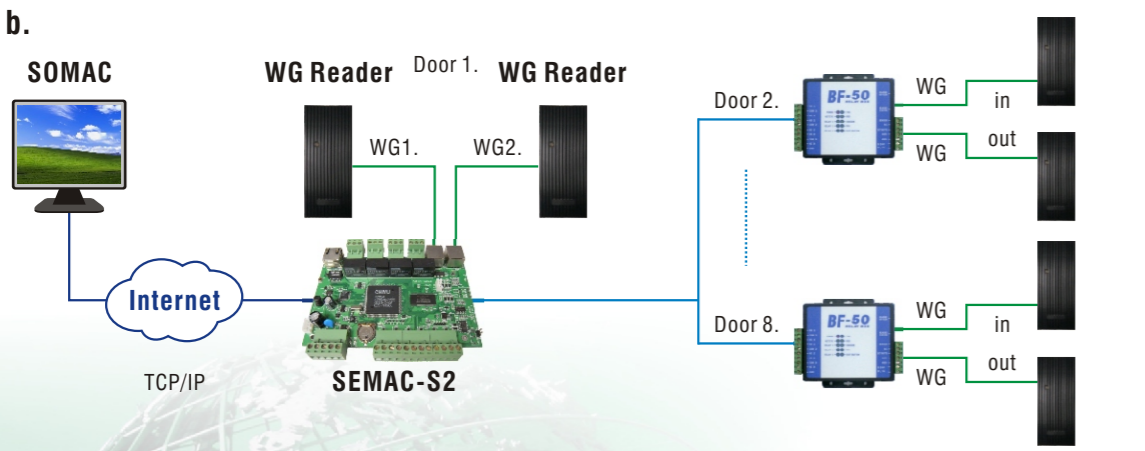
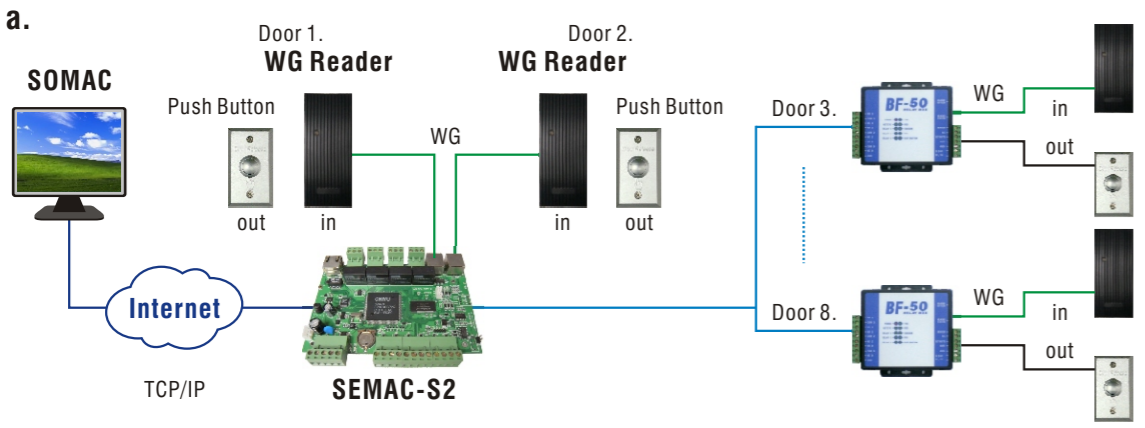

Specifications

- Cardholder capacity: 20,000~100,000 users
- Log entry capacity: 60,000~120,000 entries
- 255 Time Set/ 120 Time Zone/ 255 Group/ 100 Holiday can be configurable
- On board WIEGAND port (26/34 card format supported)
- 1~60,000 sec door open time can be selected
- 4 different groups can be assign to each cardholder
- Double-Badge/Anti-Pass-Back/Anti-Duress/ Door Interlocking configurable for higher access security level

- System alarm alert send thru Email or Mobile
- Built-in Watch Dog for system halting prevention
- IP Camera supported (Check with CHIYU)
- On board I/O connector/Relay for Alarm device/ Exit button/EM lock/Door sensor/LED indicators
- Power requirement: 9 ~ 24VDC/1A
- Dimension:143 X 93 X 17 mm