

### A. Package content

- Controller x 1, Hanger x 1, Warranty card x 1, User manual x 1, Accessory kit x 1

Accessory kit : Plastic screw x 4, Fastening screw x 4, Starlike screw x 2, Remove device tool x 1, 1N4004 x 1  
8 Pin x 1, 3Pin x 1, 2 Pin x 1

### B. Installation

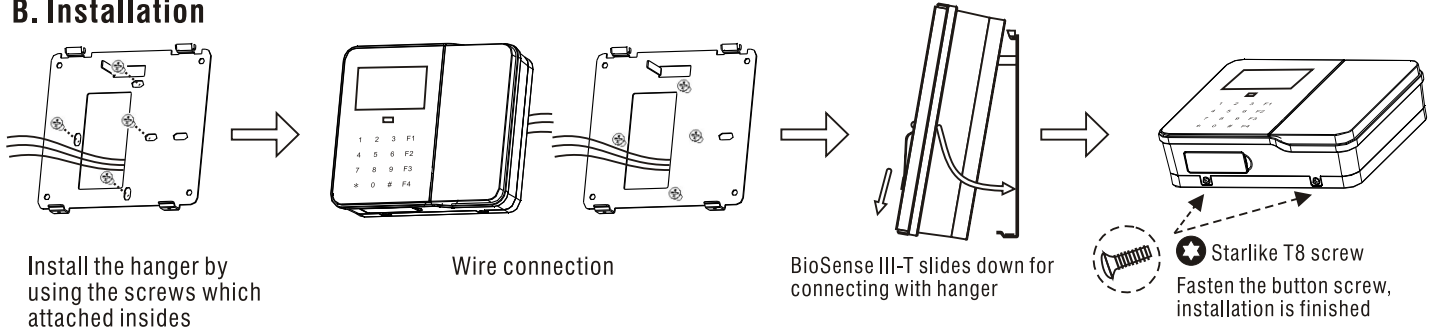

### C. Specification

- Dimension: 160.2 X 140.2 X 43.4 (mm)
- Specifications:
  - Voltage Range: 9-24VDC
  - Current Max.: 500mA (Recommended to use 1A)
  - Max distance for Wiegand is 80M

### D. Controller backside introduction

- Default IP : 192.168.0.66
- Default WEB Account : admin
- WEB Preset Password : admin
- Menu Setting Password : 111111

### E. Controller Hanger size

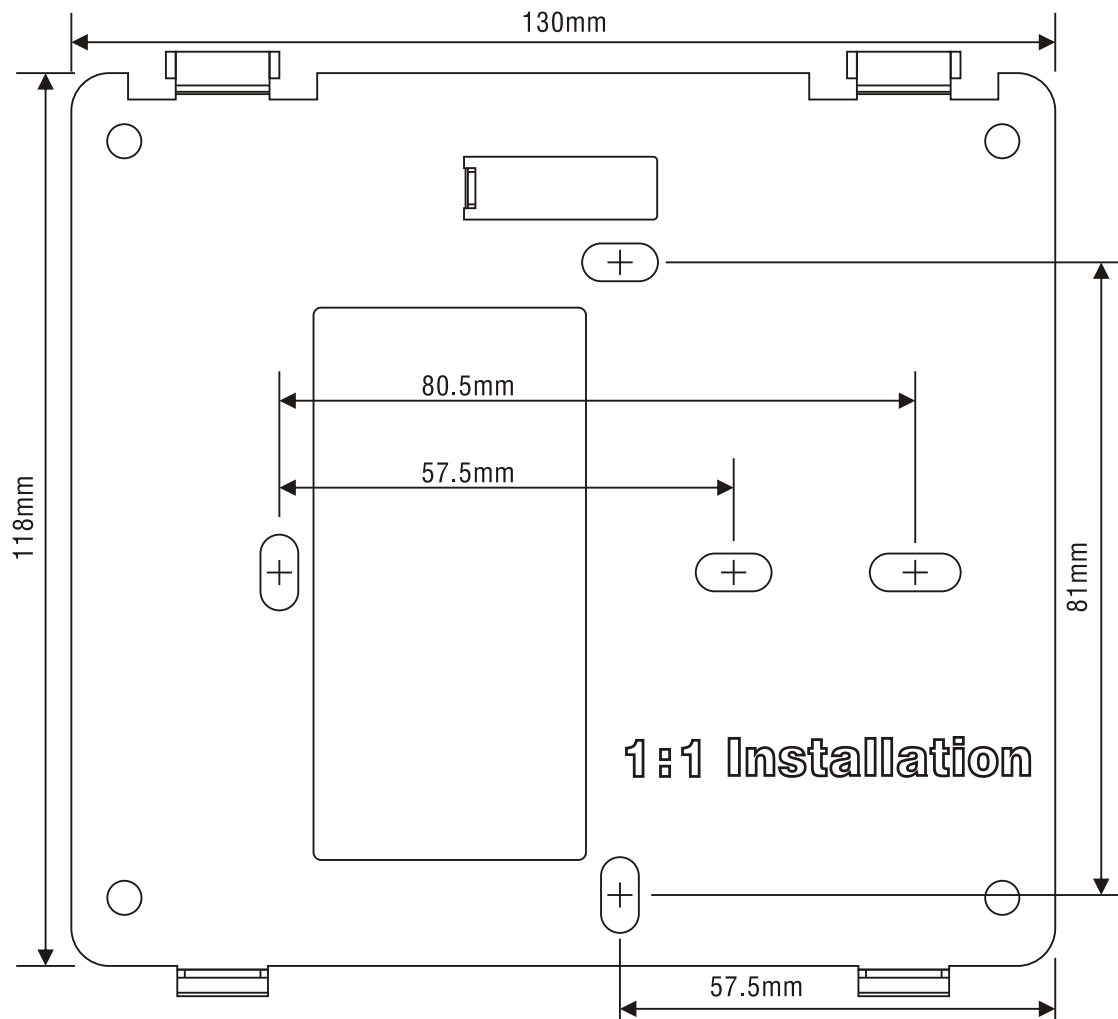

## F. Structure

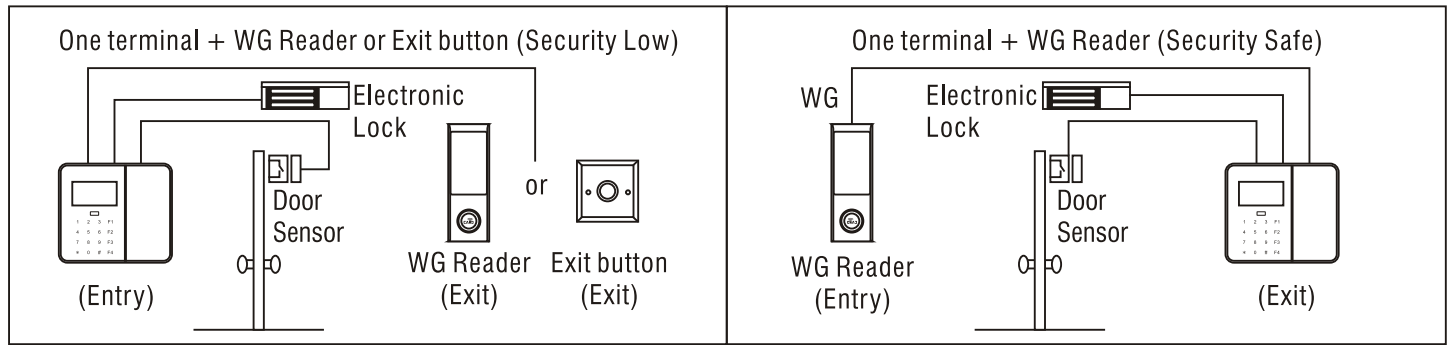

## G. Controller Backside Introduction

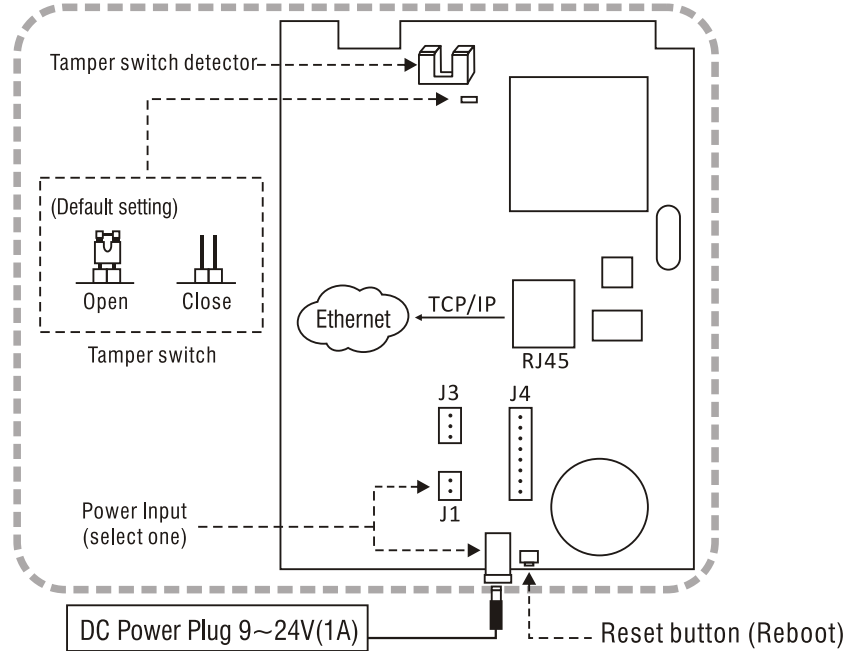

## H. Cable Color Description

### 3 pin(J3)

COM	BLACK	Door Relay
NO	BROWN	
NC	GRAY	

### 2 pin(J1)

VIN	RED	DC Power Input 9~24V
GND	BLACK	

### 8 pin(J4)

DOOR	YELLOW BLACK	Exit Button
SENS	WHITE BLACK	Door Sensor
FIRE	GREEN BLACK	Fire Alarm Input
OD0	RED WHITE	WG Output
OD1	BLACK WHITE	
GND	BLACK	GND
WID0	ORANGE	WG Input
WID1	PINK BLACK	

## Door Relay Connection

### • Fail Safe Lock

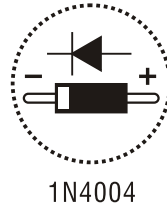
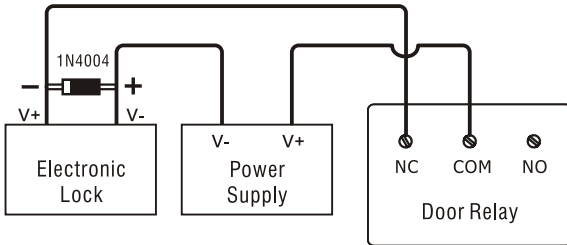

### • Fail Security Lock

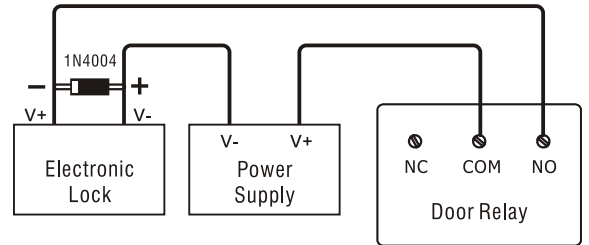

## I. Wiring Diagram

