

# Granvista Plus

## 2M-pixel Network Camera

***Not just what you think a surveillance product can do, and much more!***

Both GVP-201 and GVP-201W are of compact and high resolution (1600x1200) Network Cameras featured with superior H.264-AVC performance and multiple functions. They are perfect for indoor applications such as factories, retailer stores, residence, restaurants, hotels, schools and pre-schools, caring centers, etc. GVP-201's H.264-AVC video compression has significantly lowered down the requirements for bandwidth and storage size without compromising image quality. Motion JPEG and multiple independent video streaming are also supported for even better flexibility.

The camera offers wired Ethernet connection to the network and optional wireless connectivity (IEEE802.11b/g) for flexible installations. It includes 7 IR LEDs for illuminating the scene automatically or when requested by the user. Further functions include two-way audio with integrated high-sensitivity microphone and audio output, Micro SD card support and digital PTZ (4X) to focus any location you would like to highlight in the image.



GVP-201



GVP-201W

# Granvista Plus

## 2M-pixel Network Camera

### Main Features:

- ◆ 2 Mega CMOS image sensor (1600 x 1200 resolution)
- ◆ Amazing optical excellence
- ◆ Compact
- ◆ H.264 Multiple Streaming
- ◆ Compact design with 7 IR LEDs
- ◆ Two-way audio support with build-in high sensitive microphone
- ◆ Support Micro SD card
- ◆ Digital PTZ
- ◆ IEEE802.11b/g wireless (for GVP-201W model only)
- ◆ Periodic and motion-detection based event triggering
- ◆ Allows real-time monitoring via PC and 3G mobile phone



# Specifications of GVP-201 / GVP-201W

Video Compression	H.264 / Motion JPEG	
Video Resolution	UXGA: 1600 x 1200 HD720: 1280 x 720 SVGA: 800 x 600 VGA: 640 x 480 QVGA: 320 x 240	
Bit Rate	64k – 6M bps (CBR/VBR configurable)	
Frame Rate	30 fps @ HD720 / SVGA / VGA / QVGA 15 fps @ UXGA at both H.264/MJPEG resolution	
Image Device	2M CMOS Sensor (HD)	
Lens Type	Board Lens, Focal Length 4.9mm, F2.8	
Radiant Distance	LED on: 3-5M	
Minimum Illumination	LED off: 1.5 Lux, LED on: 0 Lux	
Video Control	Multi-Stream H.264 and Motion JPEG, controllable frame/bitrate (bandwidth), VBR/CBR control, RTSP Path, Digital PTZ to choose image area	
Image Adjustment	Brightness, Saturation, Sharpness, Exposure Control, White Balance, Exposure Control, Backlight Compensation, Rotation	
Event System	Trigger	Motion detection, or periodic triggering
	Action	File upload via FTP, Email, Micro SD card, and remote disk in LAN Notification via Email
Storage	Micro SD card (up to 32GB), remote disk in LAN, and NVR	
Network Interface	10 BASE-T/100 BASE-TX	
Wireless LAN	Wireless technology: IEEE802.11b/g (GVP-210W only) Security WEP(64/128 bit), WPA-PSK(AES/TKIP), WPA2-PSK(AES/TKIP)	

System Requirement	CPU: Intel Pentium D Processor RAM: 1G Graphic Card: 256MB
Protocols	HTTP, HTTPS, TCP/IP, IPv4, UDP, SMTP, FTP, DHCP, DDNS, NTP, DNS, ARP, RTSP, RTP, Bonjour, UPnP
Audio Capability	1 x Built-in Microphone, 1 x Audio output
Audio Compensation	u-Law PCM 8KHZ
Power Supply	DC: 5V/2A
Security	Password Protection, User access log
Power Consumption	5W
Operation Temperature	0°C - 40 °C
Operation Humidity	20% - 80% RH
Dimension (L x W x H)	60mm (W) x 26mm (L) x 76mm (H)
Net Weight	90g / 230 with stand
Operation Platform	Microsoft Windows 2000 / XP / Vista / W7
Browser	IE 7.0 or up
Conformance	CE/FCC, RoHS, WEEE
I/O Connectors	1 x RJ45 10 BASE-T / 100 BASE-TX 1 x DC Jack 1 x Audio line out 1 x Micro SD slot 1 x Default setting button
Packing contents	1 x CD (user's manual and software) 1 x Quick Installation Guide 1 x Mount Stand 1 x Ethernet Cable 1 x AC/DC Power Adapter (optional)

The above information is subject to upgrades or necessary changes without notice.

# Granvista Plus

## 2M-pixel Network Camera

Dimension Diagram

Unit:mm

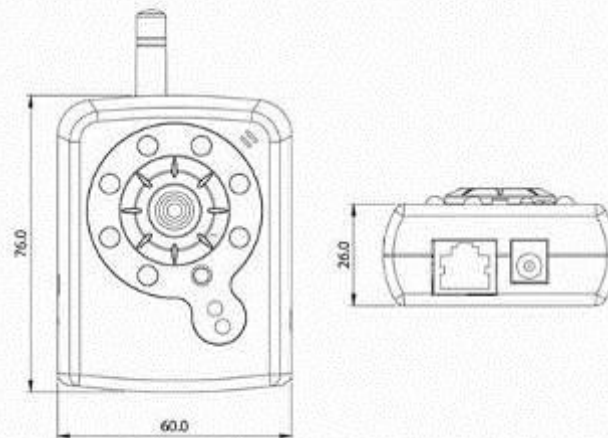

### Front Panel/Rear Panel

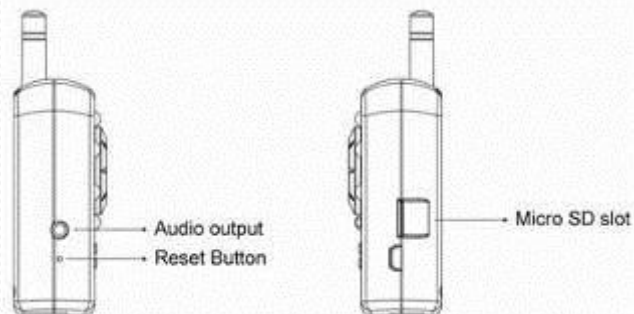
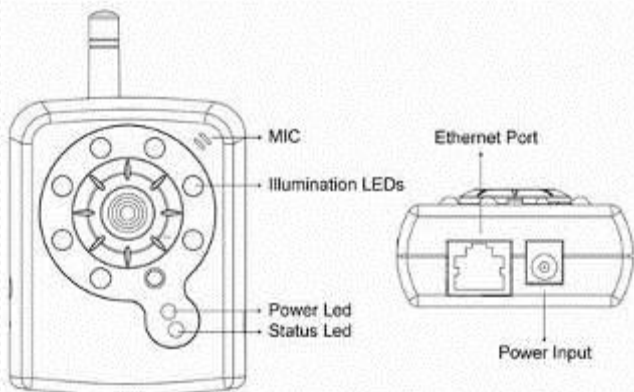

### Application

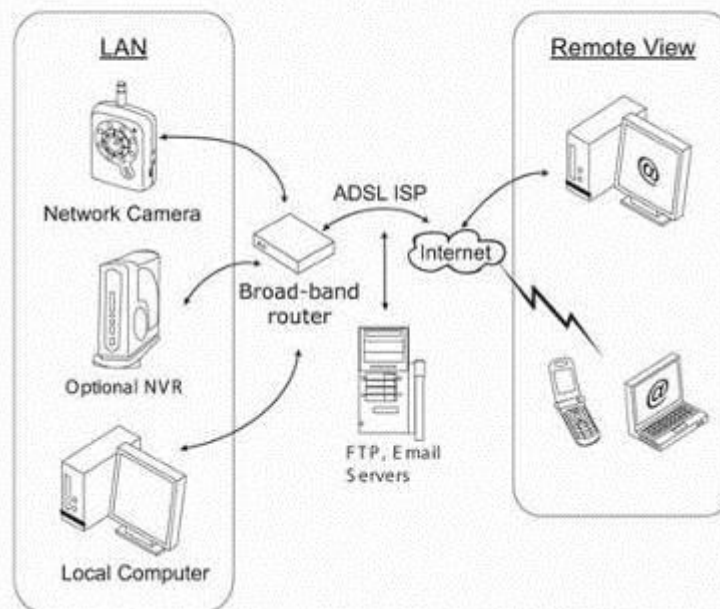

# Ideal Applications for Granvista *Plus* surveillance series



Exhibitions



Supermarket



Campus



Building lobby



Building entry



Warehouse



Hospital



Cashier



ATM machine

etc.,

# Granvista *Plus*

## 2M-pixel Network Camera

### Some of the good features need to highlight to you:

✓ In addition to the free-bundled Windows software with NVR functionality and our Linux-based dedicated NVR products for video data storage, the users may also have the video data stored into the Micro SD cards, or the shared disk spaces from the PC disks in LAN, if data storage or security are not of serious concerns.

✓ You should agree that the 1600x1200 clear images can be very helpful too. We firmly believe that the users will also enjoy following good functions.

#### - **Event photo-image or short video-clip triggering:**

- a. Motion-detection: good for intruder detection, or automatic event logging
- b. Periodic triggering: configurable, can be as frequent as one image per second

#### - **Where do the triggered photo-images go?**

- a. Directly be saved into the Micro SD card on the slot
- b. Be sent to a designated FTP server for storage
- c. Be sent to the designated Email account

- **Event notification:** An optional Email notification with pre-programmed messages can be sent out immediately to notify the user of the event

✓ As many 3G mobile phones may support Internet access thus the real-time video stream, event photo images and email notifications can be flexibly received timely.

✓ The camera's hi-sensitivity two-way audio functionality is extremely helpful for real-time monitoring and event handling

# Granvista Plus

## 2M-pixel Network Camera

**The free-bundled Windows-based NVR software is able to satisfy your basic requirements for video recording already.**

Depends on the performance of user's PC and the frame rate configured, the free-bundled Windows-based NVR software is able to connect at most 16 cameras for the ordinary user's basic recording purposes, in case security is not of a very serious concern.

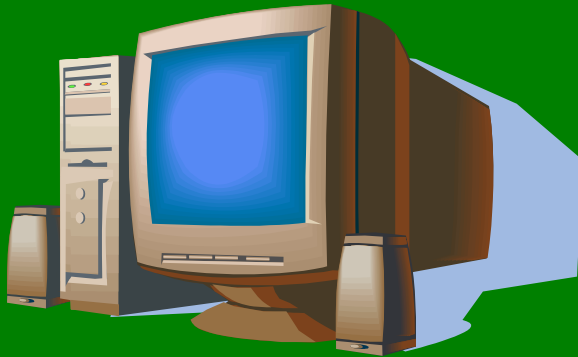

# Granvista Plus

## 2M-pixel Network Camera

The Best-Selling “Camera + SOHO NVR” Package

Up to 6 cameras connectivity capacity



GVP-NVR06



For best pricing competitiveness and SOHO NVR hardware's optimal after-sales services, strategically we allow our regional partners to only purchase the software which is stored in DOM (disk on module) from us, and to purchase and assembly the hardware locally.



# Granvista Plus NVR / CMS Network Diagram – for users' advanced requirements

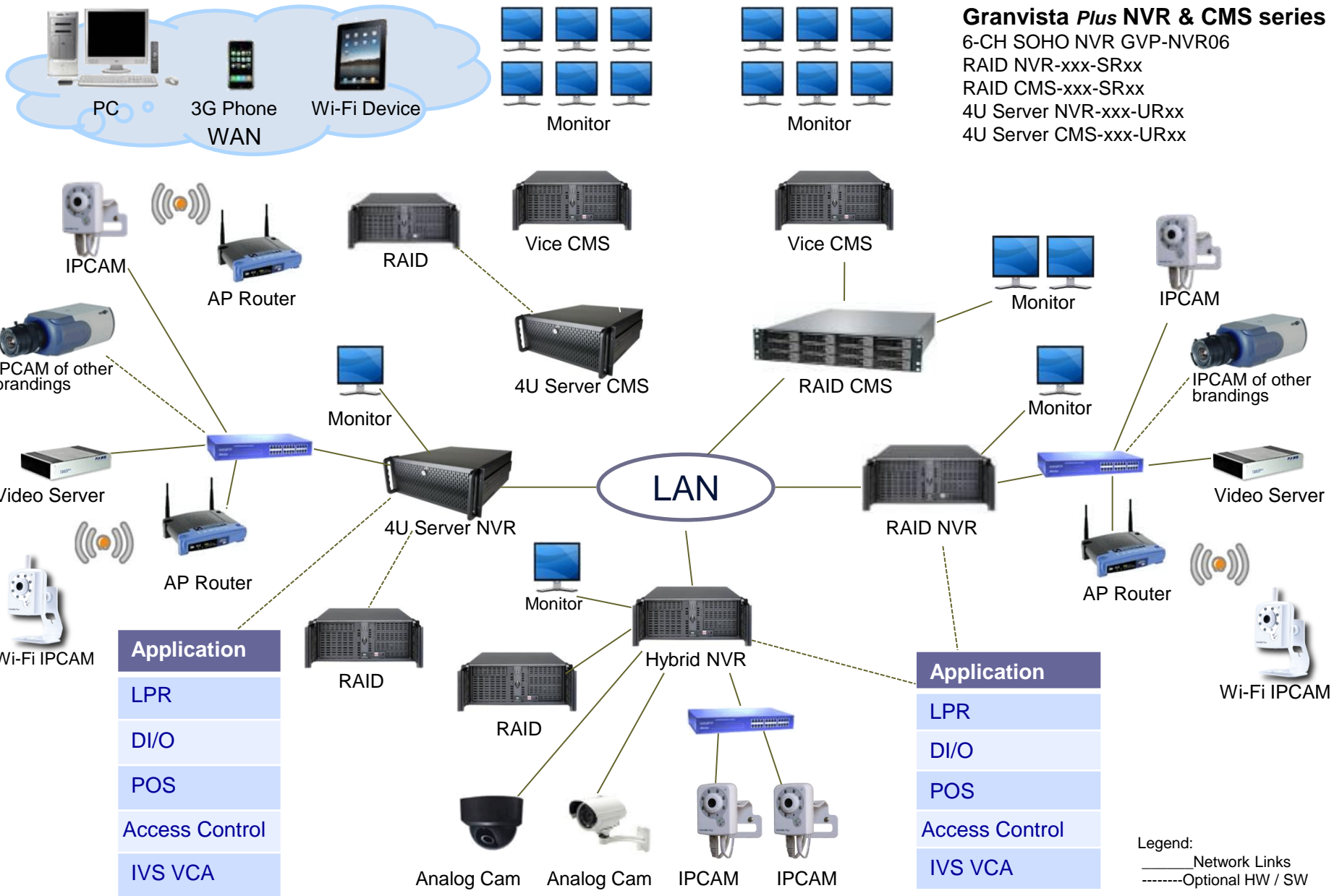

# Why Linux?

- The whole Granvista *Plus* series NVR products are of Linux system.
- Not like ordinary Windows platforms, Linux is much safer from virus attacks. The data will be much more secured, and no extra costs for purchasing Anti-virus software.
- Very user-friendly interface designed solely for users' convenience.
- Not like ordinary Windows systems which are loaded from hard disks, the NVR's programs are loaded from Flash DOM (Disk on Module) that they do not have the disadvantages of PC's hard disks which may easily be damaged in case of sudden power interruption.
- Free from all the troublesome product upgrades which Windows OS requires repeatedly against new security issues found.
- Big save that no purchase on Windows OS is required.

# Some misunderstandings need to be clarified

- **Do the users need Internet connections to get the network cameras work?**
  - ✓ The users do not necessarily need Internet connections to make the systems work.
  - ✓ If the users want to access the camera views from remote, or Internet, the users will need Internet connection; otherwise, no need.
  - ✓ The camera can directly connect to PC through the Ethernet ports without the hub or switch too. The PC may connect many cameras if the hub or switch is available.
  - ✓ At the installation sites such as individual houses, retailer stores or offices what the users need are the PCs, network hubs/switches, and the cameras to make the systems work. Even if the Ethernet connection is not available or has been cut off, the cameras still may keep on working to store video or snap-shot images into its Micro-SD card if available.
  - ✓ Although the cameras may work without Internet connection, but Internet applications surely are good features for the modern users.
- **Do the users need to pay for other software?**
  - ✓ No, basically the users do not need to spend extra money for additional software.
- **Is NVR a must for video recording?**
  - ✓ No, the users may store the data into the cameras' Micro SD slot (up to 32GB), the PC hard disk in local area network too. NVR is optional for more serious security requirements.

# Granvista Plus

## 2M-pixel Network Camera

To see is to believe, following links are some demonstrations for your reference. Please click on each individual icon for demonstration video clip. Please be sure to use bigger screen with higher resolution, and select “full-screen” to see the excellent performance.

video's  
original  
setting

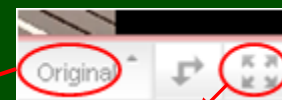

full screen



Outdoor  
view in day  
time



Outdoor  
view in  
evening



Night view



Dark room  
with built-in IR  
4-5 meters  
away



Lobby  
with dim  
light

Please note that due to the bandwidth constraint of your Internet connections, the performance of video streaming may not be as good as replaying the recorded files from local PC. From experiences usually the streaming performance will be better if you “replay” one more time. Please contact us to get original files for further assessments if necessary.